

 SilensPRO®
REVOLUTION



Silens Pro *Revolution*®
Machine-roomless lifts

450-630 Kg

Here at last: a revolution in machine-roomless lifts.

In 1997 we designed and built our first machine-roomless lift with a gearless permanent-magnet machine, well before the majority of our competitors. After two decades of constant development, innovation and thousands of lift systems installed across five continents, we have taken the next significant step forward with the **Silens Pro Revolution**® - a machine-roomless lift system destined once again to radically transform the lift industry.



Revolutionary in technological terms



Silens Pro Revolution® is the first MRL lift that operates with the new **ALEC system (Automatic Learning Elevator Control)**.

ALEC is a new technological concept based around the *machine learning* concept which gives the lift a new level of intelligence never seen before.

- ✓ **Varispeed**
Brand-new technology that converts the **Silens Pro Revolution**® in to the first lift on the market that travels faster than its nominal speed.
- ✓ **Direct Approach System**
Guarantees the smoothest and most precise ride on every single trip.
- ✓ **Smartech car and landing indicators**
New 7" car and landing indicators that keep passengers up to date in real time regarding their trip.
- ✓ **SIRES (Shaft Intelligent Revolutionary Elevator System)**
A concept based on a PESSRAL device with an electronically activated over-speed governor, electromechanical safety gear and absolute positioning that:
 - Guarantees maximum **safety** of passengers.
 - Allows **automatic shaft learning**, drastically reducing commissioning costs.



Revolutionary in simplifying lift engineer tasks

The **ALEC system** includes new features specifically designed for lift professionals:

- ✓ **New App** designed by lift engineers for lift engineers to facilitate maintenance and technical support tasks.
- ✓ Maximum simplicity thanks to the latest Plug and Play technology (pre-wired and pre-tested) as well as **Quick Spin** technology that instantly synchronises the gearless machine and drive removing expensive commissioning costs.

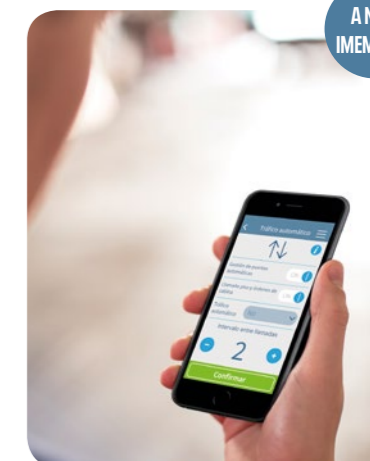

Revolutionary in its energy-efficiency

Our **Silens Pro Revolution**® lifts have been awarded the maximum possible energy-efficiency ratings according to the VDI 4707 and ISO 25745-2 standard.



- ✓ The incorporation of **Varispeed** and **the Direct Approach System**.
- ✓ The **gearless drive unit** significantly lowers energy consumption and does not require lubricants.
- ✓ **Stand-by mode** is activated whenever the lift is not in use.
- ✓ Energy-efficient lighting with **LED spotlights**.
- ✓ Designed and built in compliance with **ISO 14001**, the international standard which sets the basis for an **effective environmental management system**.

High standards on a global scale

Gearless machine: compact & energy efficient as well as easier to install due to its reduced weight.

The car platform, flooring, ceilings and sling arrangement make for a **robust and hard-wearing** product.

The **machined guide rails** are of the highest quality and are delivered cut to size to suit the particular project.

Automatic fire-rated doors, side or central opening are safe and reliable. Available in brushed stainless steel or epoxy finish.

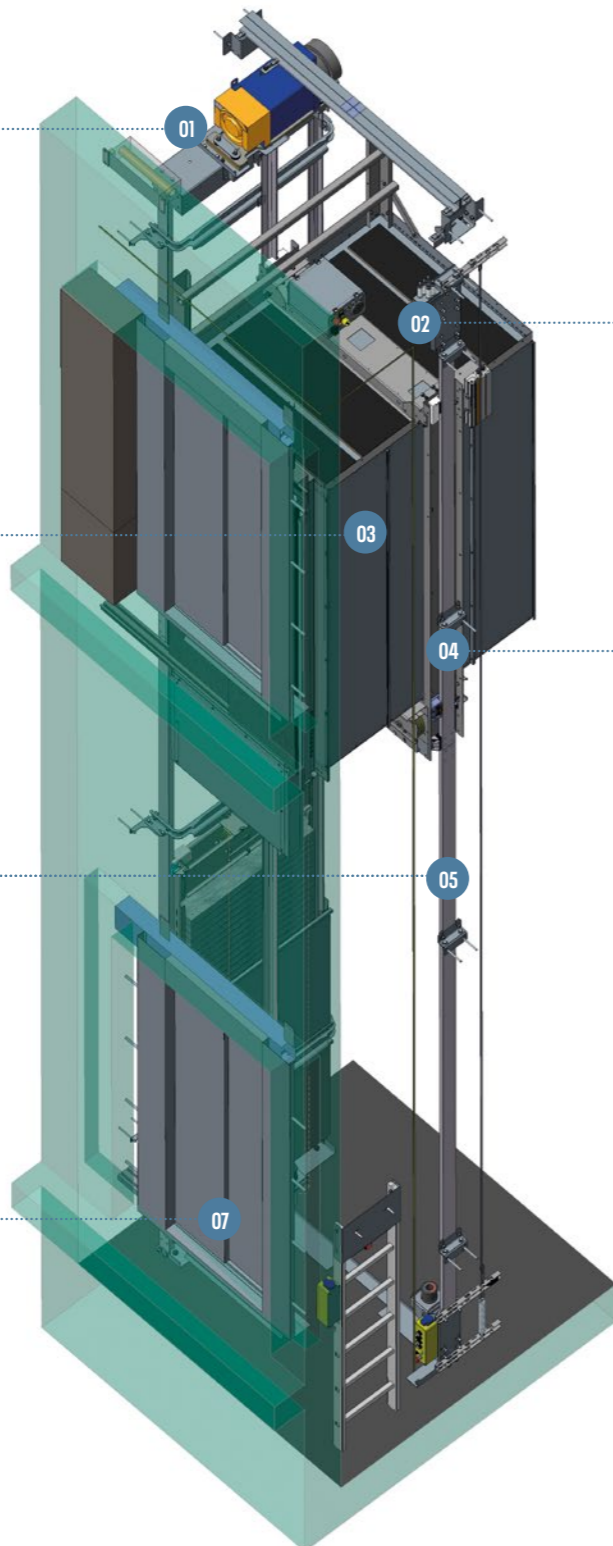

In full compliance with:

- 2014/33/EU Directive
- EN 81-20/50 Standards
- EN 81-28 Remote alarms

*Optional:
EN81-73 · EN81-70

State-of-the-art **electronic overspeed governor**.

The robust **conventional under-slung sling arrangement** allows for excellent ride quality. A modern **electrically triggered safety gear** replaces the traditional linkage bar mechanism whilst providing a lower tripping speed.

06 In-shaft safety devices (limit switches, absolute positioning, door zone magnets, final limits) are integrated into a LI-MAX Safe device.



Varispeed:

Faster travel for optimum traffic management.

For the first time as a standard feature, the **Silens Pro Revolution[®]** incorporates innovative **Varispeed** technology that allows the lift to travel faster, cut passengers' travel and waiting times and increase the building's lift traffic capacity.

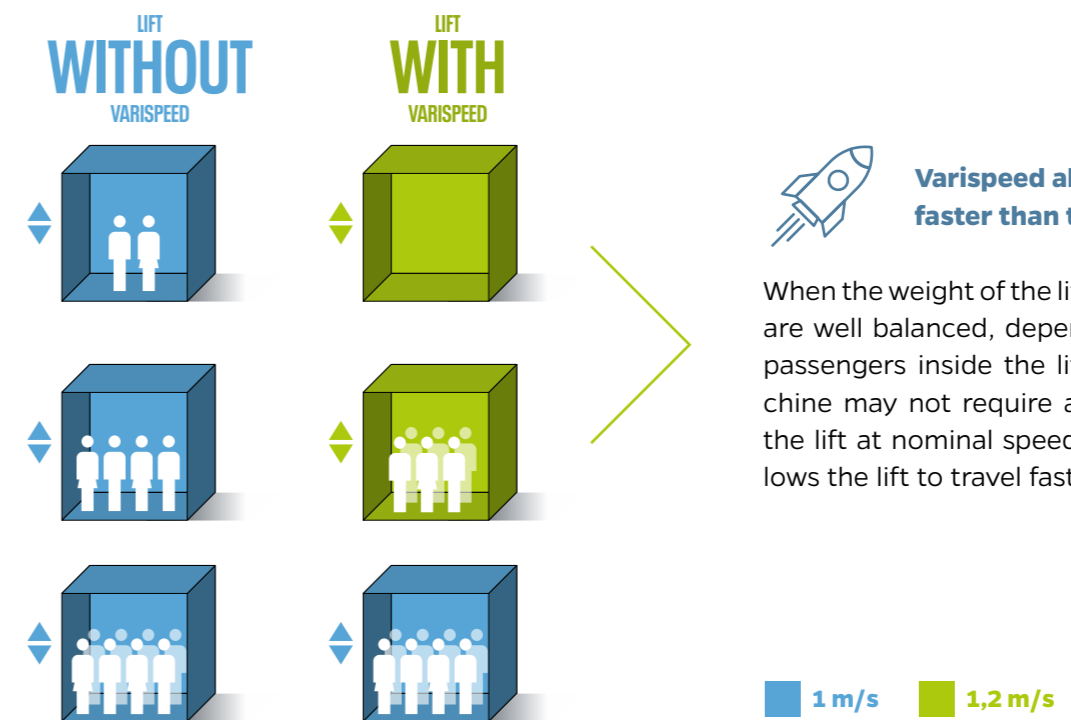

Varispeed allows lifts to travel faster than their rated speed.

When the weight of the lift car and counterweight are well balanced, depending on the number of passengers inside the lift car, the gearless machine may not require all of its power to move the lift at nominal speed. This unused power allows the lift to travel faster.

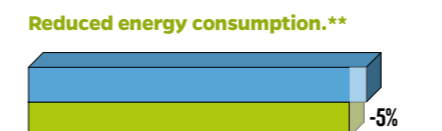
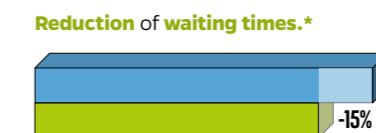
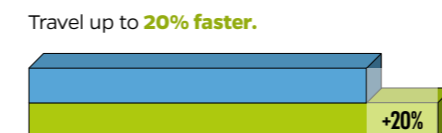

* & ***: based on traffic analysis during the late evening in a residential building with 24m travel, 9 floors and an occupation of 10 people per floor.

** based on data collected of random traffic in a residential building over 6 floors with 15.5m travel.



Direct Approach System

Supreme precision and comfort.

The **Silens Pro Revolution**® offers passengers a unique travel experience characterised by smooth and silent travel with no abrupt movements.

Our **Direct Approach System** allows the lift's control system to calculate the optimum speed curve for each trip, avoiding the delays typically experienced with lifts that do not benefit from this function.

As a result, lift travel and waiting times are drastically reduced and passenger experience in terms of comfort, smoothness of travel and car-to-landing stopping accuracy are significantly improved.

On top of that, the Direct Approach System gets rid of the need for a series of sensors and devices inside the lift shaft, thereby simplifying, shortening and economising on the lift installation process and subsequent maintenance work.



SIRES Intelligence reinvented

SIRES introduces a new concept in elevation intelligence.

For the first time, **Silens Pro Revolution**® includes as standard **SIRES (Shaft Intelligent Revolutionary Elevator System)**. The concept is based around a PESSRAL* device providing absolute positioning in the lift shaft using the latest magnetic tape technology.

SIRES provides continuous real-time information on the lift car's location in the shaft, precise to within less than 1mm. **SIRES** allows us to optimise electromagnetic devices and delivers many other benefits (see adjacent box).

What does SIRES provide?

- ✓ **Automatic shaft learning** drastically reducing installation costs.
- ✓ **Installation & maintenance:** faster, easier and more adaptable.
- ✓ **Lift car location:** always available in real time.
- ✓ **Fault detection:** made simpler by its advanced diagnostic capacities and the removal of outdated components.
- ✓ **Covers various safety functions** of the EN81-20 / 50 standard such as bottom limits, uncontrolled movement, overspeed control and triggering.
- ✓ It also covers other safety functions such as door area positioning for the emergency rescue control system.
- ✓ The PESSRAL device is **silent and resistant to dust, smoke and humidity**.

* The PESSRAL system is designed for control, protection or monitoring based on one or more programmable electronic devices, including all elements of the system such as power supplies, sensors and other input devices, data highways and other communication paths, and actuators and other output devices, used in safety related applications.



Modern design - all to the customer's taste

The new range of design options specifically developed for the **Silens Pro Revolution**® caters for our customers' most demanding tastes, right down to the last detail, both in terms of appearance and of function. The result is a relaxed user experience and the capacity to shine, whatever the architectural setting.



200 *Revolution Series*

200 Revolution Series lift cars are built with galvanised steel sheeting and clad with plastic laminates available in a wide range of colours or with stainless steel in a choice of different patterns.

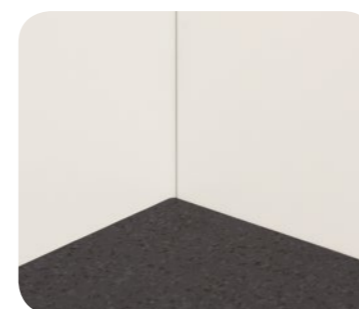
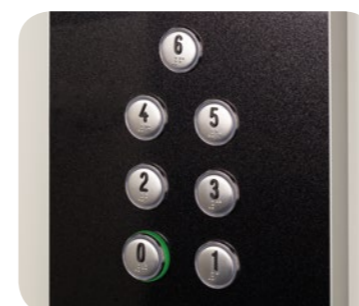

- **In-car lighting:** direct, using LED spotlights from either range.
- **Lift-car doors and front returns:** finished in stainless steel.
- **Car operating panel:** BCR 1 model which includes the 7" TFT colour indicator.
- Hard-wearing **car floors** available in a range of rubber finishes.
- **Handrails** (optional): finished in AISI 304 stainless steel. Lift car is also available with handrails on all walls or without.
- **Mirror** (optional): covering half of the back wall of the car.
- Design in full accordance with 2014/33/EU Directive, EN 81-20:2014, EN 81-50:2014 and EN 81/70:2018.



300 Revolution Series

300 Revolution Series lift cars are built with galvanised steel sheeting and clad with high-pressure laminates in a wide range of colours.



- **In-car lighting:** direct, using LED spotlights from eihier range.



- **Lift-car doors and front returns:** finished in stainless steel.

- **Car operating panel:** BCR 2 model which includes the 7" TFT colour indicator.

- **Skirtings:** finished in aluminium.



- Hard-wearing **car floors** available in a range of rubber finishes.

- **Handrails** (optional): finished in AISI 304 stainless steel. Lift car is also available with handrails on all walls or without.

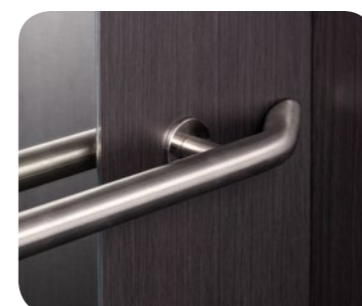

- **Mirror** (optional): covering two-thirds of the car's back wall.

- Design in full accordance with 2014/33/EU Directive, EN 81-20:2014, EN 81-50:2014 and EN 81/70:2018.

Car wall panels

200 Revolution[®] Series

Skinplate



Stainless steel

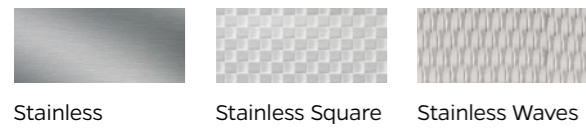

300[®] Revolution Series

High-pressure laminates



Flooring

Rubber

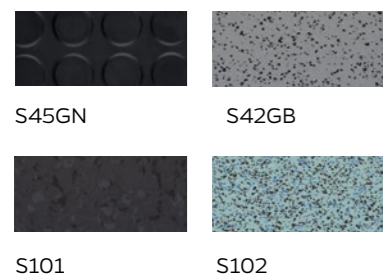

Granite



Marble

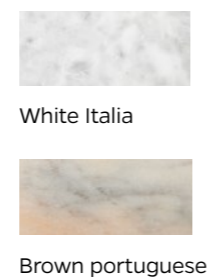

Handrails



PSR

Lighting



LED Spotlights



Square LED spotlights

Car operating panels, landing push stations & indicators (I)

Landing Push Stations



BER1*

BER2**

BER3***

Landing push buttons



PEEB

* Push buttons installed directly in the door frame.

** Flush mounted on door frame.

*** Surface mounted on door frame.

Landing indicators



FERV



Smarttech HR 7" indicator.
EN81-70 option: Includes for direction of travel arrow and gong.



HLER - Car doorjamb (EN81-70)



Car operating panels, landing push stations & indicators

Car operating panels



BCR1

BCR2

Car push-buttons

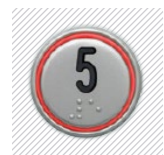

Stainless steel push-buttons with tactile legend and braille (EN81-70 compliant).

PCEB

Lift car Smartech display



Lift availability before travel. The screen tells you if the lift is available for use.

Smartech AutoTest Function. Checks and displays the correct functioning of the safety components and system before the start of each journey.

Position & direction. Shows the location of the lift within the building at all times, as well as direction of travel.

Destination floor & time remaining before arrival. Indicates the floor to which the lift is travelling and the time remaining before arrival, expressed in seconds.

Speed. Passengers are kept informed in real time of the car's speed on each journey, from departure until arrival at the destination floor.

Energy consumption. Indicates if the lift is consuming energy or generating it during travel, thereby reducing the building's operating costs.

Arrival at destination floor alert. Informs passengers when the lift reaches the destination floor.

Date & time. Displays the time and date in real time.

Load & passenger capacity. Indicates the maximum permissible load, in kilograms, and the maximum number of passengers that can travel in the lift car.

Landing Smartech HR display*



Welcome messages. The screen greets passengers with messages corresponding to the particular time of day.

Position & direction. Indicates to passengers waiting on a landing the location of the car and its direction of travel in real time.

Flashing LED display by the lift entrance. Alerts passengers to the imminent arrival of the lift.

Situation reports. The display transmits relevant information to passengers: such as when there are too many people in the lift car, when the lift door is blocked and when people are entering or leaving the car, among others.

Lift arrival countdown. The display shows a progress bar and countdown in seconds, accurately updated in real time, so that passengers know exactly when their lift will arrive.

Energy consumption. Indicates if the lift is consuming energy or generating it during travel, thereby reducing the building's operating costs.

Voice messages. The screen device shares travel information with passengers via a voice synthesiser built into the door frame. Its volume is automatically adjusted according to the particular time of day.

*Optional

All the visual and acoustic messaging has been designed in full accordance with EN 81-70:2018 (Safety rules for the construction and installation of lifts. Particular applications for passenger and goods passenger lifts. Part 70: Accessibility to lifts for persons including persons with disability).



The best possible choice for lift professionals

The **Silens Pro Revolution**[®] has been specifically designed to assist the work of lift professionals throughout the working life of the lift system.

A fully-integrated solution

The innovative **ALEC system** represents another step in the integration of all electrical and mechanical components of the lift, raising benefits to another level.

Intelligent packaging

The **Silens Pro Revolution**[®] is delivered on-site in packaging designed to facilitate the work of installation personnel. All the lift components and parts are delivered in a logically-organised series of packs that are clearly identified and strictly ordered according to their place in the installation sequence. The lift system comes with all the parts labelled and numbered and with all the detailed checklists, documents and installation manuals required.

Fast & straightforward installation

The **Silens Pro Revolution**[®] can be installed in under 100 hours.

Plug and Play

Thanks to our Plug and Play manufacturing concept our electrical packages are supplied pre-tested and pre-wired to the specific gearless machine that is shipped with the lift.

Quick Spin

Instant synchronisation of the gearless machine and VF drive removing expensive commissioning costs.

Easy to maintain

Maintenance work on a **Silens Pro Revolution**[®] lift system by the qualified service technician is safe, quick and supremely straightforward.

Permanent technical support service

We offer clients all the technical support they require, whether mechanical or electrical: our highly qualified staff advise and assist them in real time and in their own language.

Spare parts guaranteed

The availability of original spare parts is guaranteed, as is the full traceability of all replacement parts installed.

Speed of delivery

Once an order has been received and confirmed, the corresponding **Silens Pro Revolution**[®] lift system will be manufactured in just four weeks.

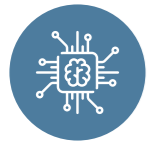

Altamira II control system: Silens Pro Revolution's[®] brain

The Altamira II control system has been completely designed and manufactured by IMEM Lifts alone. It was conceived to control, with maximum precision, all the actions of any lift or group of lifts in the **Silens Pro Revolution[®]** range.

Altamira II is ready to solve, in a simple way, both the most common functions and the most complex and sophisticated, avoiding traditional electro-mechanical solutions.

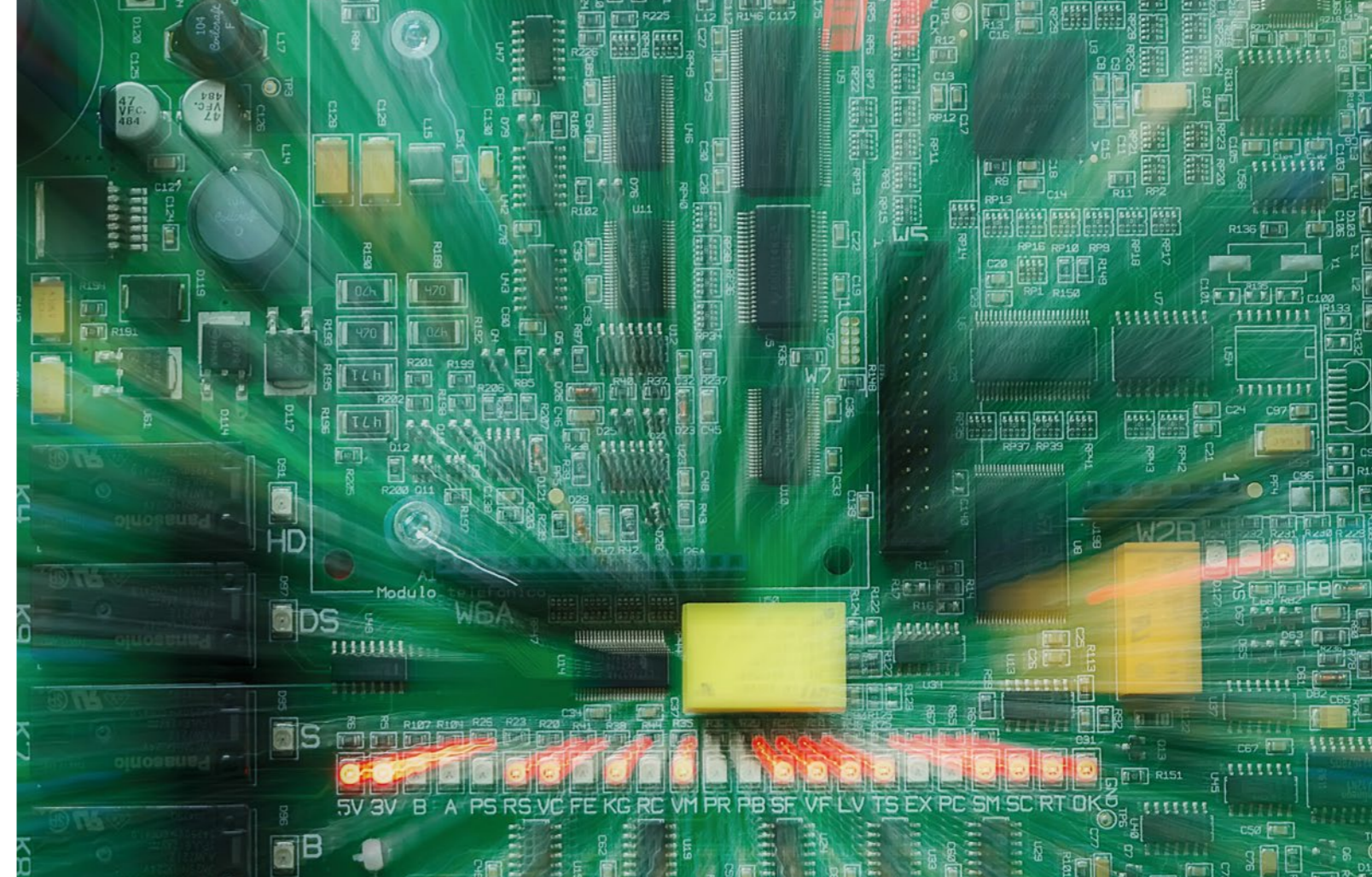

Seamless integration for perfect performance

Altamira II is fully integrated with the mechanisms of the entire **Silens Pro Revolution[®]** lift range. Therefore, in a **Silens Pro Revolution[®]** lift, the mechanical and the electrical act as one to provide exceptional functionality and performance.

Altamira II minimises the sensors and components required, making it possible to utilise space to the maximum. It provides optimum travel comfort for the lift and reduces electrical consumption.

As electrical and mechanical manufacturers we not only offer our customers lifts that provide integrated electrical and mechanical solutions with perfect compatibility: we also offer integral technical support to our customers, saving time and providing efficient support throughout the lifecycle of our lifts.

Easy and quick installation

Altamira II is supplied pre-assembled, pre-connected and pre-tested which simplifies installation and minimises any margin of error.

Perfectly configured inverter and machine operating patterns match the operation of **Altamira II** with the mechanics of every **Silens Pro Revolution[®]**

Installation times are reduced thanks to the almost complete elimination of traditional sensors and magnets.

Altamira II integrates software that allows a single person to perform a levelling operation in minutes and from inside the lift car.

Easy maintenance

A simple smartphone allows, without the need for cables or additional tools, rapid, easy and user-friendly access to the control system to perform lift maintenance tasks. The **App** provides access to documentation, manuals and communication with our customer support department.

In the event of an unexpected anomaly, **Altamira II** will automatically proceed to correct it in a self-learning process by recording the event for later analysis by the maintenance department without interrupting the lift service.

Our technical support department can provide remote support and real-time monitoring of lifts via telephone or internet.

Remote monitoring

The remote monitoring system allows lifts installed in one or more buildings to be run from a control room. This system is based on CAN Bus technology that allows monitoring of lifts, detection and reading of faults in real time, control of groups of lifts, analysis of equipment performance and many other functions.

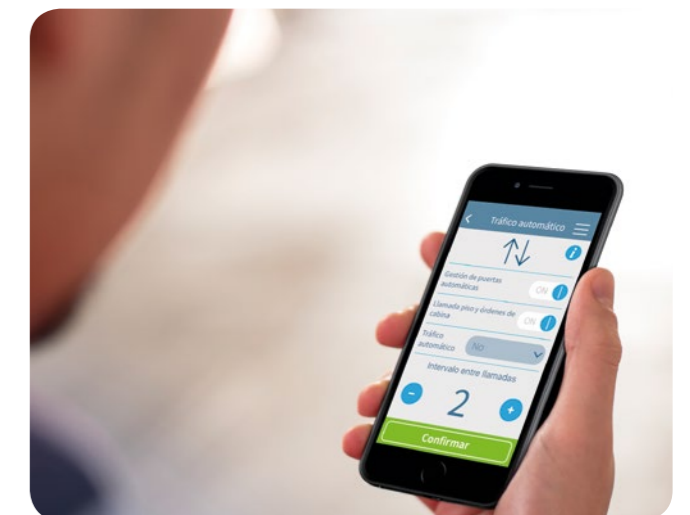

Operational and service functions

Direct approach

The lift approaches the floor with no intermediate speeds to stop gently at the floor level. The position of the car is calculated at all times without the need for magnets.

Homing Mode

The lift car returns to the specified homing floor. You can set any floor as the return floor.

Maximum no. of calls

Limited number of car calls registered. Anti-vandal mode.

Fire control

In the event of a fire, a control is activated that sends the lift to the fire emergency floor. If the lift is going away from the fire emergency floor, it will stop at the first possible stop and without opening the doors, it will return to the fire emergency floor. If the lift is going in the direction of the fire emergency floor, it will not stop until it arrives at that floor. This complies with EN81-73. When this movement is completed, it can return to normal operation by means of reset or not.

Stand-by mode

Disconnects the lighting inside the car as well as the car and landing displays, thus reducing the electrical consumption of the lift.

Car fan

There is a timer to activate/deactivate the fan.

Service control keyswitch

Only calls made from the car operating panel are registered.

Multiple movement functions

Multiple

A group of up to 4 lifts can be controlled.

Limited out of service

Allows a group of lifts to self-manage a singular lift with continuous faults and leave it out of service whilst other lifts handle calls.

Standard Function

Optional Function

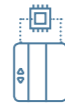

Door operation functions

Fast closing of doors

This allows the time between stops to be shortened by means of a push button in the car that can be activated if there are car calls registered.

Nudge

The doors close slowly in the event of a prolonged interruption of the safety edge, notifying the persons in the car visibly and/or acoustically.

Safety edge

Safety edge according to EN81-20.

Self-diagnosing safety edge

Autodiagnosis of the safety edge in which the door sensors are automatically checked.



Signalisation and indicator functions

Departure Gong, ascending and descending tones - EN81-70 -

Activates a sound with an ascending scale for ascent and a descending scale for descent.

Overload function

The display gives a visual and audible indication to the users of overloading inside the car.

Voice synthesizer

This is a voice synthesizer that emits informative messages concerning the operation of the lift.



Emergency operation functions

Manual rescue

Manual rescue can be of two types, one by opening the brake and car movement subject to the balance of the car or by means of a high power UPS and directional push buttons that raise or lower the lift.

Emergency ceiling light in car

In the event of a power cut, an emergency light in the car operating panel illuminates in accordance with EN81-20.

RATED LOAD • 450kg / 6 people **ROPING • 2:1** **MAXIMUM SPEED • 1.2 m/s**

Entrances Angle	Car		Shaft		Min. Headroom CH 2175mm	Pit	Door type (C/O)
	Width (A)	Depth (B)	Width (C)	Depth (D)			
1/0°	950	1300	1450	1550	3400	1050	Side opening 2P 800 (AUGUSTA EVO)
2/180°	950	1300	1450	1670			
1/0°	1000	1200	1500	1450			
2/180°	1000	1200	1500	1570			
1/0°	1000	1250	1500	1500			
2/180°	1000	1250	1500	1620			
1/0°	1000	1300	1500	1550			
2/180°	1000	1300	1500	1670			
1/0°	1050	1200	1550	1450			
2/180°	1050	1200	1550	1570			
1/0°	950	1300	1750	1520			
2/180°	950	1300	1750	1590			
1/0°	1000	1200	1750	1420			
2/180°	1000	1200	1750	1490			
1/0°	1000	1250	1750	1470			
2/180°	1000	1250	1750	1540			
1/0°	1000	1300	1750	1520			
2/180°	1000	1300	1750	1590			
1/0°	1050	1200	1750	1420			
2/180°	1050	1200	1750	1490			

RATED LOAD • 630kg / 8 people **ROPING • 2:1** **MAXIMUM SPEED • 1.2 m/s**

Entrances Angle	Car		Shaft		Min. Headroom CH 2175mm	Pit	Door type (C/O)
	Width (A)	Depth (B)	Width (C)	Depth (D)			
1/0°	1050	1450	1550	1700	3400	1050	Side opening 2P 800 (AUGUSTA EVO)
2/180°	1050	1450	1550	1820			
1/0°	1100	1400	1600	1650			
2/180°	1100	1400	1600	1770			
1/0°	1150	1350	1650	1600			
2/180°	1150	1350	1650	1720			
1/0°	1100	1400	1600	1650			
2/180°	1100	1400	1600	1770			
1/0°	1150	1350	1650	1600			
2/180°	1150	1350	1650	1720			
1/0°	1050	1450	1750	1670			
2/180°	1050	1450	1750	1740			
1/0°	1100	1400	1750	1620			
2/180°	1100	1400	1750	1690			
1/0°	1150	1350	1750	1570			
2/180°	1150	1350	1750	1640			
1/0°	1100	1400	1925	1620			
2/180°	1100	1400	1925	1690			
1/0°	1150	1350	1925	1570			
2/180°	1150	1350	1925	1640			

All dimensions are based on the door sill being 25mm inside the lift shaft.

Operational ranges

Maximum travel	Up to 60 m (Maximum 15 floors)
Pit	Minimum: 1050 mm · Maximum: 1550 mm
Headroom	Minimum: 3400mm (CH 2175mm) and 3500mm (CH 2275mm)
Minimum width	Car width + 500 mm
Maximum width	Car width + 1100mm
Shaft	With side opening doors and door sill completely in the shaft, add 75mm per opening side. With central opening doors and door sill completely in the shaft, add 40mm per opening side. Option for doors completely in the shaft.
Minimum depth	1200 mm
Maximum depth	1450 mm
Lift car	Minimum width 950 mm Maximum width 1150 mm Standard height 2175mm with 2000mm high doors (option for 2275mm with 2100mm high doors)

- EN81-70: T1 car dimensions
- EN81-70: T2 car dimensions
- EN81-70: T2 car dimensions with a 800mm C/O only for existing buildings.

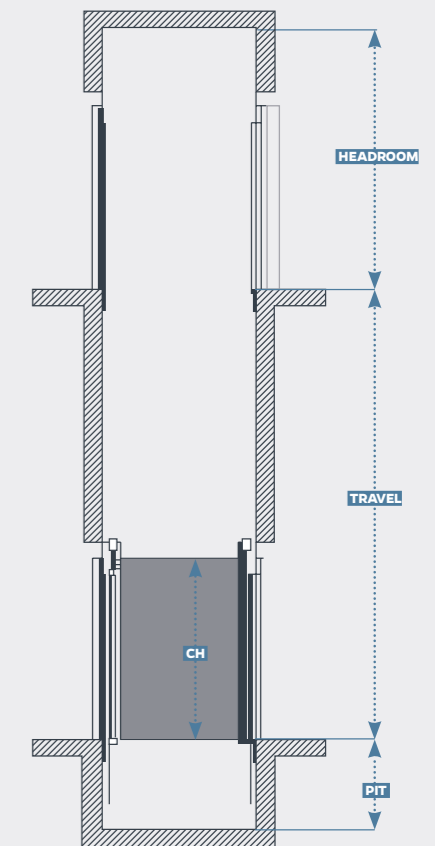
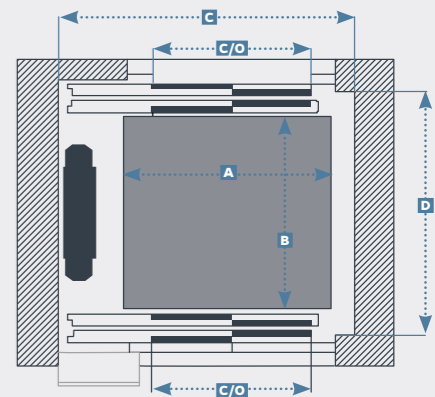



BRADFORD[®]
LIFTS

0800 689 5036

mail@bradfordlifts.com
www.bradfordlifts.com